

1

2

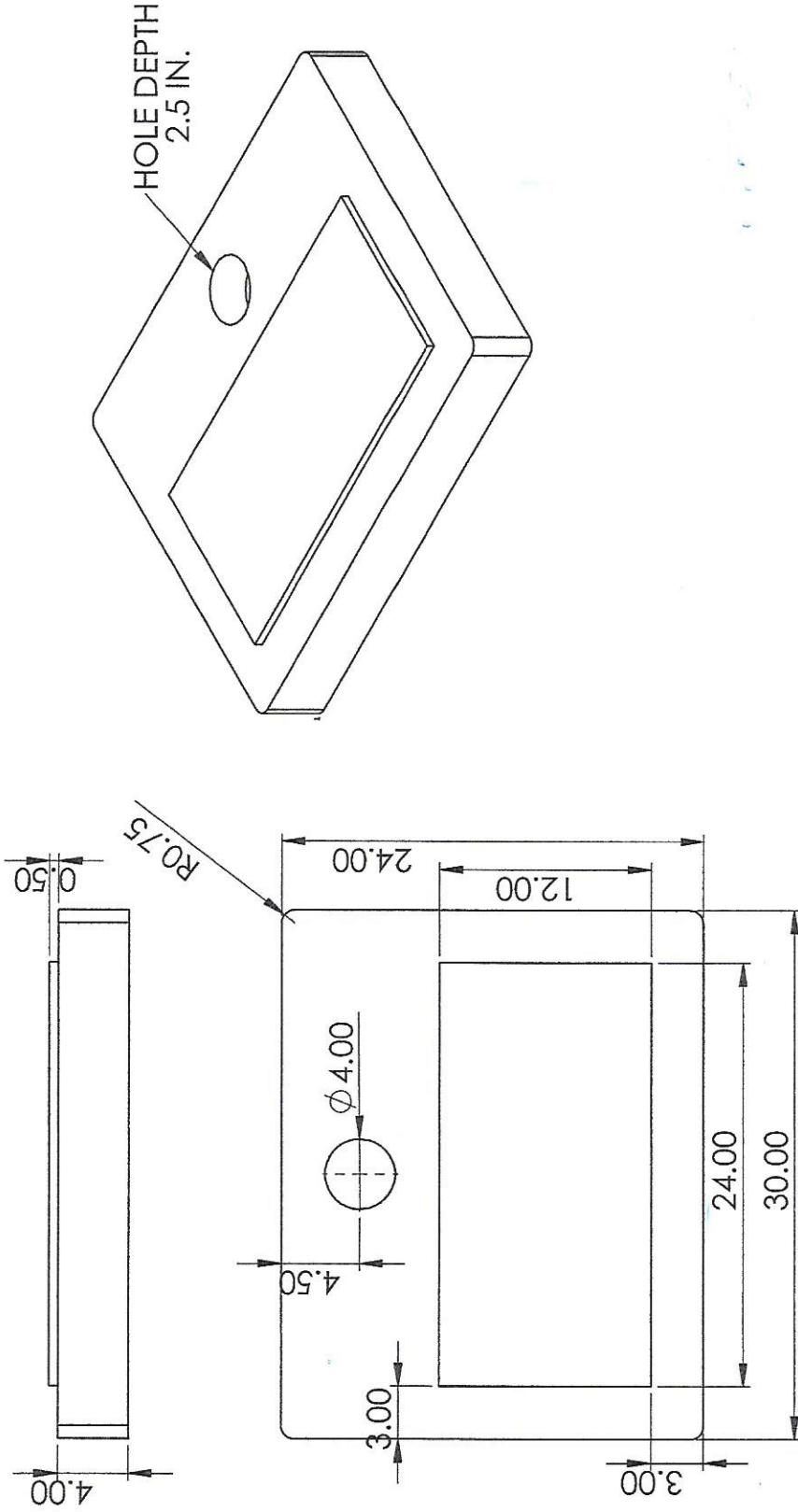

B

B

A

A

D. PROCTOR ENGINEERING

TITLE:

FLAT MARKER 1

SIZE DWG. NO. REV

A

SHEET 1 OF 1

DRAWN	CHECKED	ENG APPR.	MFG APPR.	Q.A.	COMMENTS:	NAME	DATE
UNLESS OTHERWISE SPECIFIED:							
DIMENSIONS ARE IN INCHES							
TOLERANCES: FRACTIONAL ±							
ANGULAR: MACH ± BEND ±							
TWO PLACE DECIMAL ±							
THREE PLACE DECIMAL ±							
INTERPRET GEOMETRIC TOLERANCING PER:							
MATERIAL							
FINISH							
NEXT ASSY				USED ON			
APPLICATION				DO NOT SCALE DRAWING			

PROPRIETARY AND CONFIDENTIAL
 THE INFORMATION CONTAINED IN THIS DRAWING IS THE SOLE PROPERTY OF <INSERT COMPANY NAME HERE>. ANY REPRODUCTION IN PART OR AS A WHOLE WITHOUT THE WRITTEN PERMISSION OF <INSERT COMPANY NAME HERE> IS PROHIBITED.

1

2

1

2

B

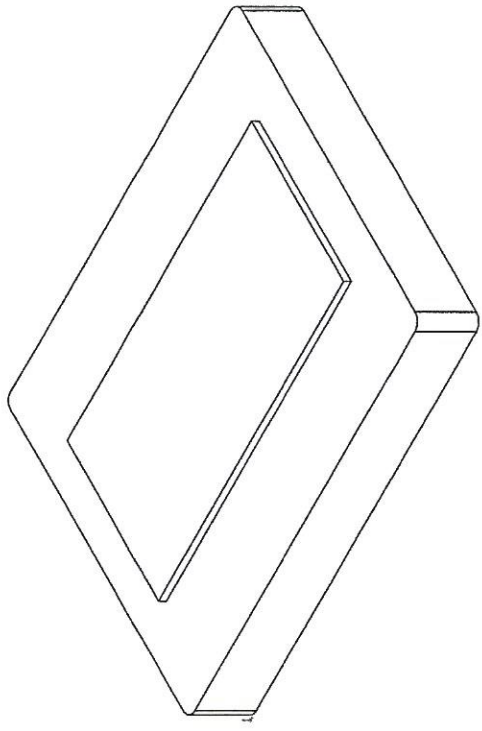

B

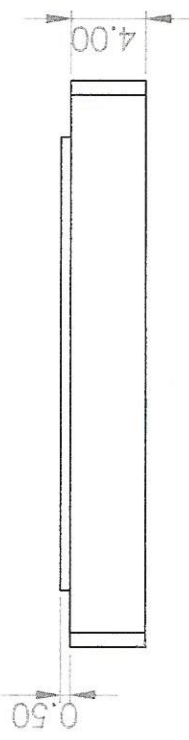
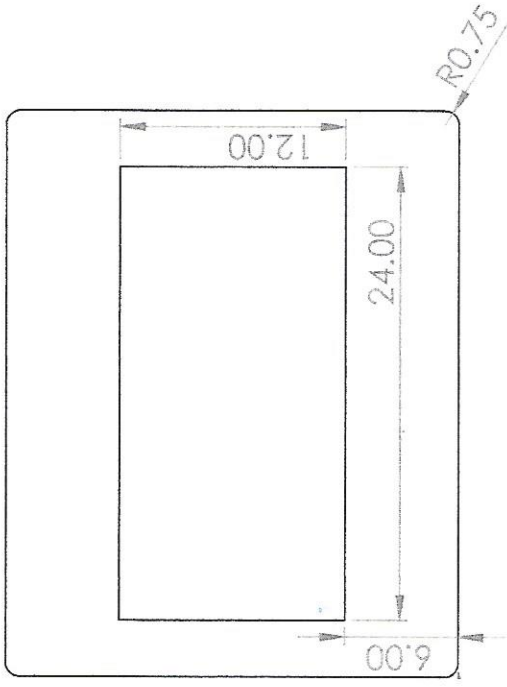

A

A

Proctor Engineering, Inc.

TITLE:

FLAT MARKER 2

SIZE DWG. NO. REV

A

SCALE: 1:10 SHEET 1 OF 1

NAME	DATE
DRAWN	
CHECKED	
ENG APPR.	
MFG APPR.	
Q.A.	
COMMENTS:	

UNLESS OTHERWISE SPECIFIED:
 DIMENSIONS ARE IN INCHES
 TOLERANCES:
 FRACTIONAL ±
 ANGULAR: MACH ± BEND ±
 TWO PLACE DECIMAL ±
 THREE PLACE DECIMAL ±
 INTERPRET GEOMETRIC TOLERANCING PER MATERIAL
 FINISH

DO NOT SCALE DRAWING

PROPRIETARY AND CONFIDENTIAL
 THE INFORMATION CONTAINED IN THIS DRAWING IS THE SOLE PROPERTY OF <INSERT COMPANY NAME HERE>. ANY REPRODUCTION IN PART OR AS A WHOLE WITHOUT THE WRITTEN PERMISSION OF <INSERT COMPANY NAME HERE> IS PROHIBITED.

NEXT ASSY USED ON APPLICATION

1

2

1

2

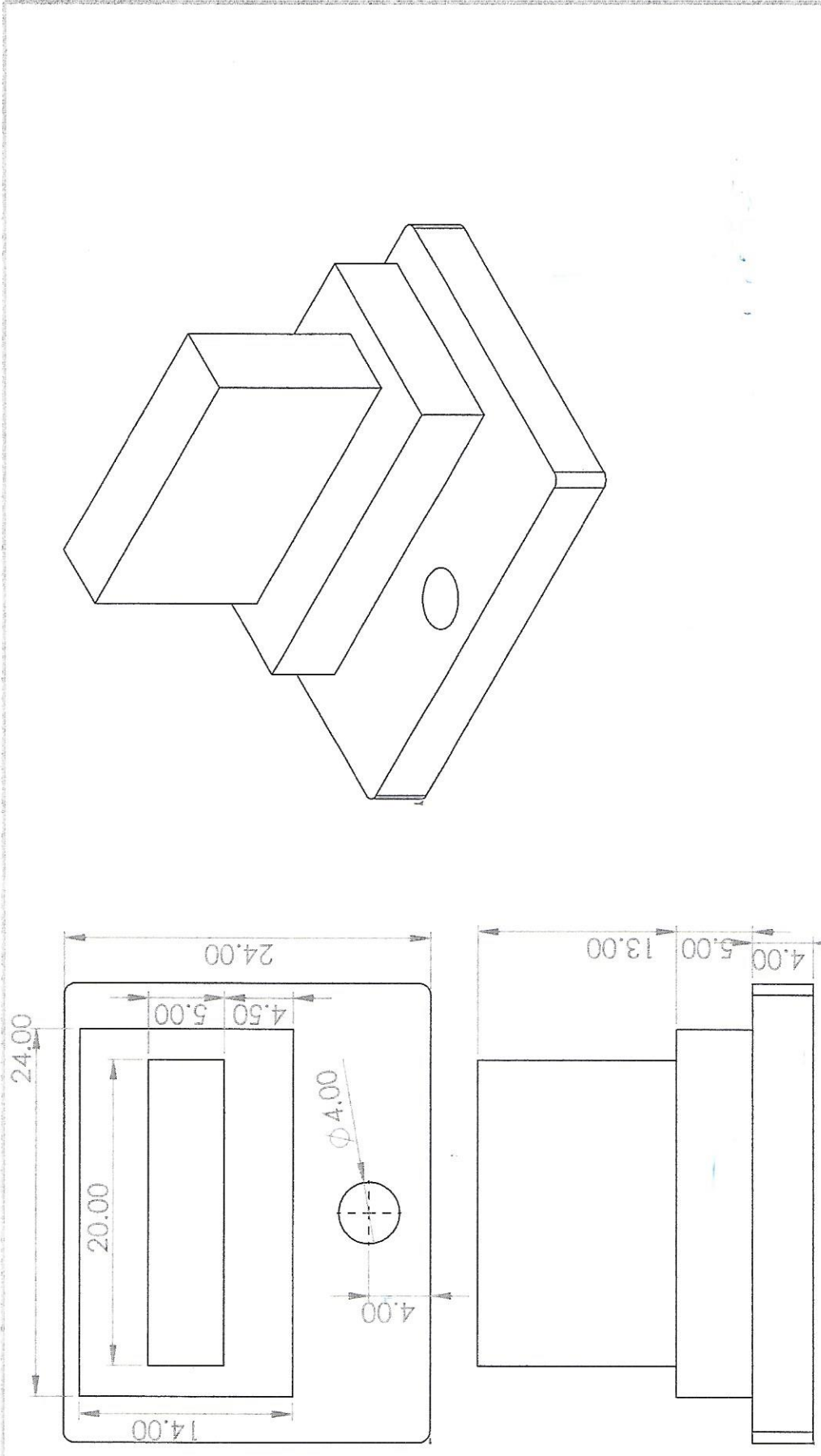

B

B

A

A

UNLESS OTHERWISE SPECIFIED:		NAME	DATE	Proctor Engineering, Inc.
DIMENSIONS ARE IN INCHES	DRAWN			
TOLERANCES:	CHECKED			
FRACTIONAL: ±	ENG APPR.			
ANGULAR: MACH ± BEND ±	MFG APPR.			
TWO PLACE DECIMAL ±	Q.A.			
THREE PLACE DECIMAL ±	COMMENTS:			
INTERPRET GEOMETRIC TOLERANCING PER:				
MATERIAL				
FINISH				
NEXT ASSY	USED ON			
APPLICATION	DO NOT SCALE DRAWING			
PROPRIETARY AND CONFIDENTIAL THE INFORMATION CONTAINED IN THIS DRAWING IS THE SOLE PROPERTY OF <INSERT COMPANY NAME HERE>. ANY REPRODUCTION IN PART OR AS A WHOLE WITHOUT THE WRITTEN PERMISSION OF <INSERT COMPANY NAME HERE> IS PROHIBITED.		TITLE: MONUMENT SINGLE		SIZE A DWG. NO. REV
		SCALE: 1:10		SHEET 1 OF 1

1

2

1

2

B

B

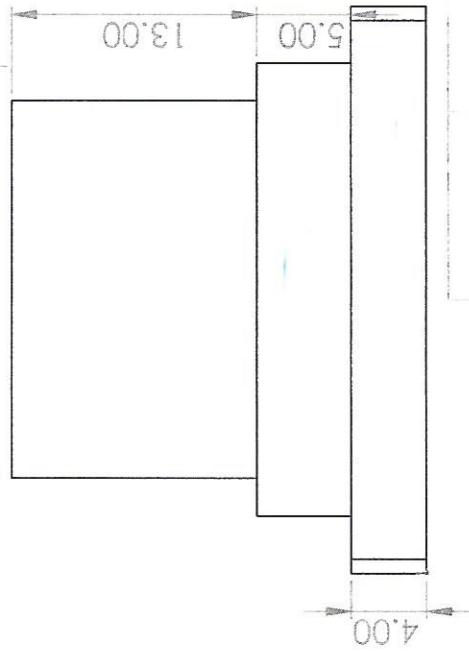
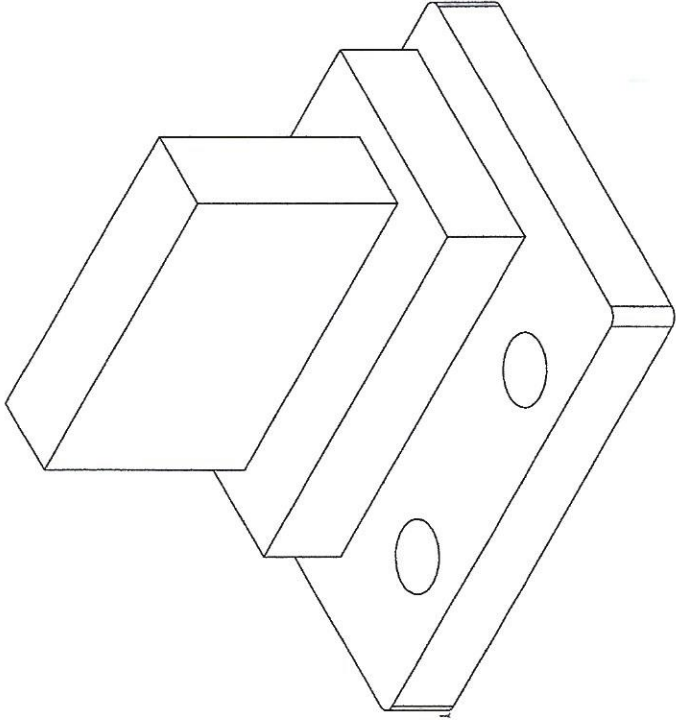
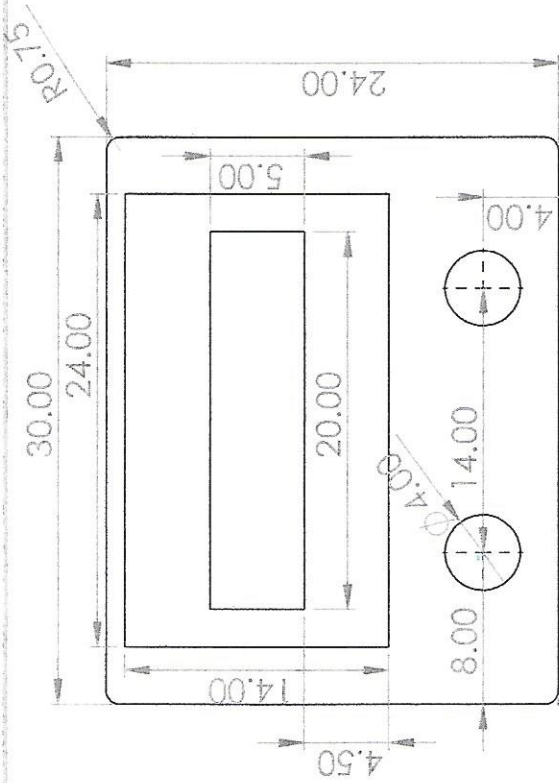

A

A

Proctor Engineering, Inc.

TITLE:

MONUMENT MARKER 2

SIZE DWG. NO. **A** REV

SCALE: 1:10 SHEET 1 OF 1

UNLESS OTHERWISE SPECIFIED:	NAME	DATE
DIMENSIONS ARE IN INCHES	DRAWN	
TOLERANCES:	CHECKED	
FRACTIONAL ±	ENG APPR.	
ANGULAR: MACH ± BEND ±	MFG APPR.	
TWO PLACE DECIMAL ±	Q.A.	
THREE PLACE DECIMAL ±	COMMENTS:	
INTERPRET GEOMETRIC TOLERANCING PER:		
MATERIAL		
FINISH		
DO NOT SCALE DRAWING		

PROPRIETARY AND CONFIDENTIAL
 THE INFORMATION CONTAINED IN THIS DRAWING IS THE SOLE PROPERTY OF <INSERT COMPANY NAME HERE>. ANY REPRODUCTION IN PART OR AS A WHOLE WITHOUT THE WRITTEN PERMISSION OF <INSERT COMPANY NAME HERE> IS PROHIBITED.

NEXT ASSY USED ON APPLICATION

1

2